



200

OXE200

674 NM (497FT-LB) OF TORQUE

oxemarine.com

TECHNICAL SPECIFICATION

OXE200

The OXE Diesel outboards combine the reliability of an inboard with the flexibility of an outboard. A more environmentally friendly solution, the OXE Diesels offers increased serviceability, longer lifespan, lower emissions and fuel consumption. Operational range is increased by over 60%, compared to a gasoline outboard. The reliability and high torque of the automotive diesel engine are manifested throughout the OXE Diesel outboard series. The transmission allows for interchangeable gear ratios, providing the user with the option to use the engine as both an enduring workhorse and a high-speed solution. OXE Diesel outboards are also certified in compliance with regulations set forth in EPA TIER III, IMO TIER II (MARPOL VI TIER 2), RCD, and CCS.

The OXE200 delivers 200 hp and 415Nm (306ft-lb) of torque. With the high torque gear ratio on the primary belt transmission, the unit delivers up to 674Nm (497ft-lb) of torque on the propeller shaft.

Learn more at oxemarine.com

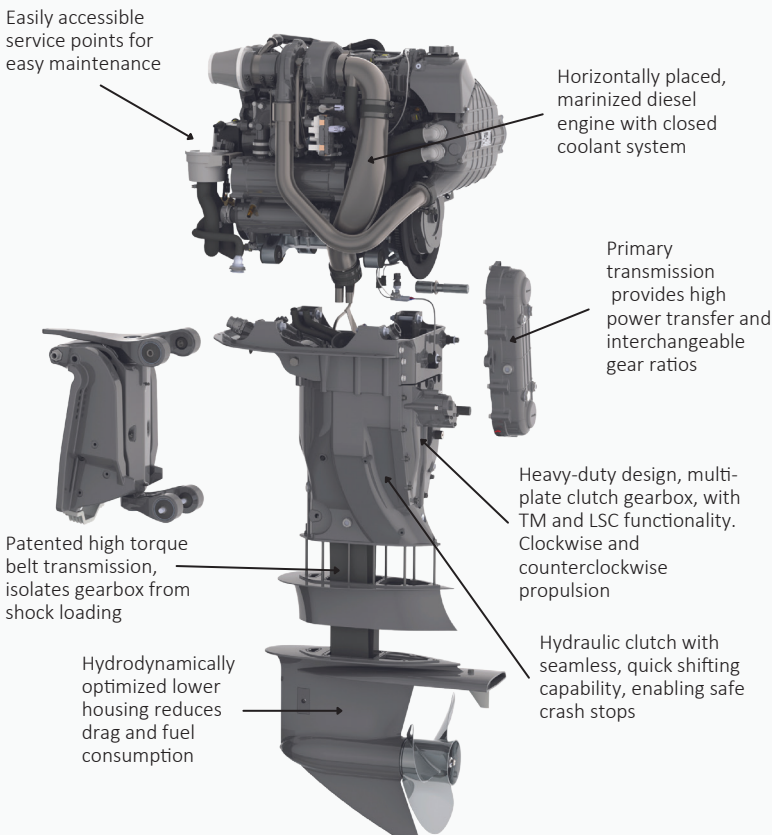

Performance

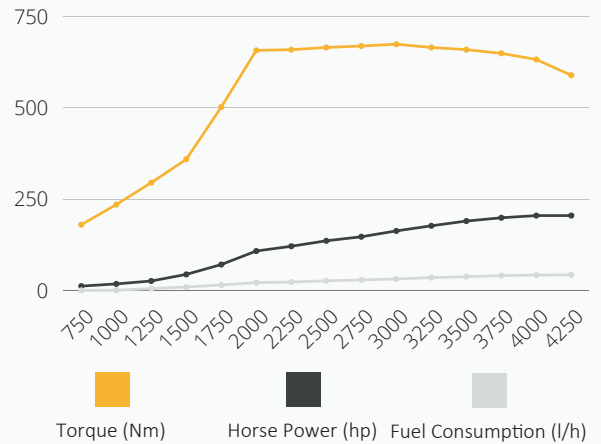

Consumption, Range and Emissions

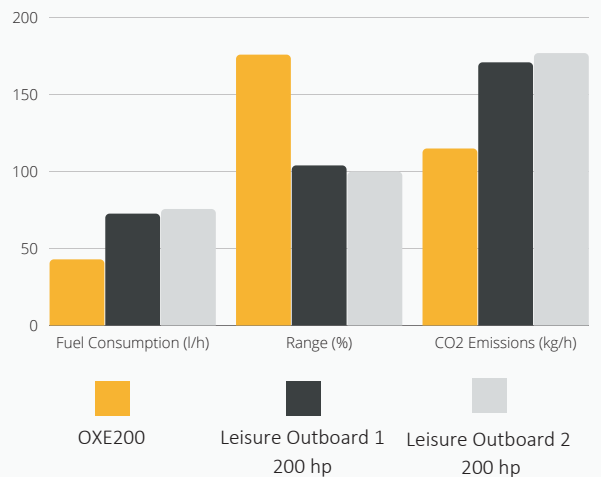

SERVICE INTERVAL: 200 hrs / 800 hrs

ENGINE TYPE: Diesel, L4. Block built by GM

DISPLACEMENT: 2.0 L

INTAKE: Turbocharged, intercooled

TORQUE: 415 Nm at 2500 rpm

POWER: 200 hp at 4100 rpm

FUEL: Diesel EN 590, ASTM D 975 No.1 No.2. JIS KK2204, F54 & F75, biofuels: HVO100 and B7

WEIGHT: 350 kg

ALTERNATOR OUTPUT: 130 Amp

RIG LENGTH: 25" or 33"

COOLING: Closed cooling circuit

STARTING: Electric

STEERING OPTIONS: Hydraulic, Electronic Power Steering, Joystick

SHIFT: CANbus, Electro-hydraulic

CLUTCH: Hydraulic multi-friction plate

GEAR RATIOS: 1.73:1 and 2.17:1

DIMENSIONS: (25" leg), L994 H1880 W678 (mm)

